

入力孔
Input hole

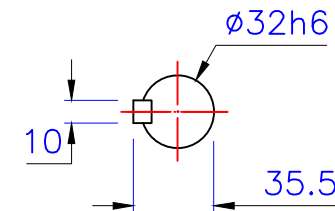

出力轴
Output shaft

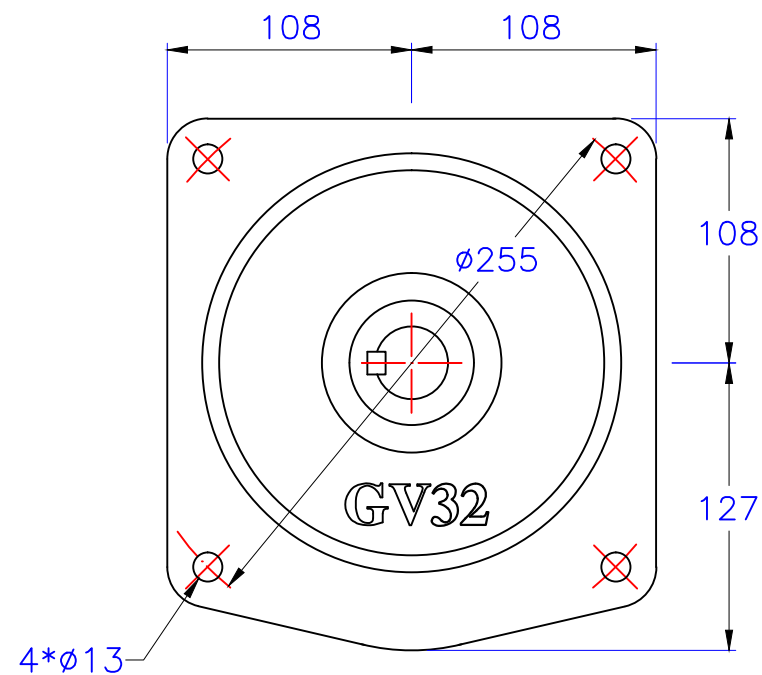
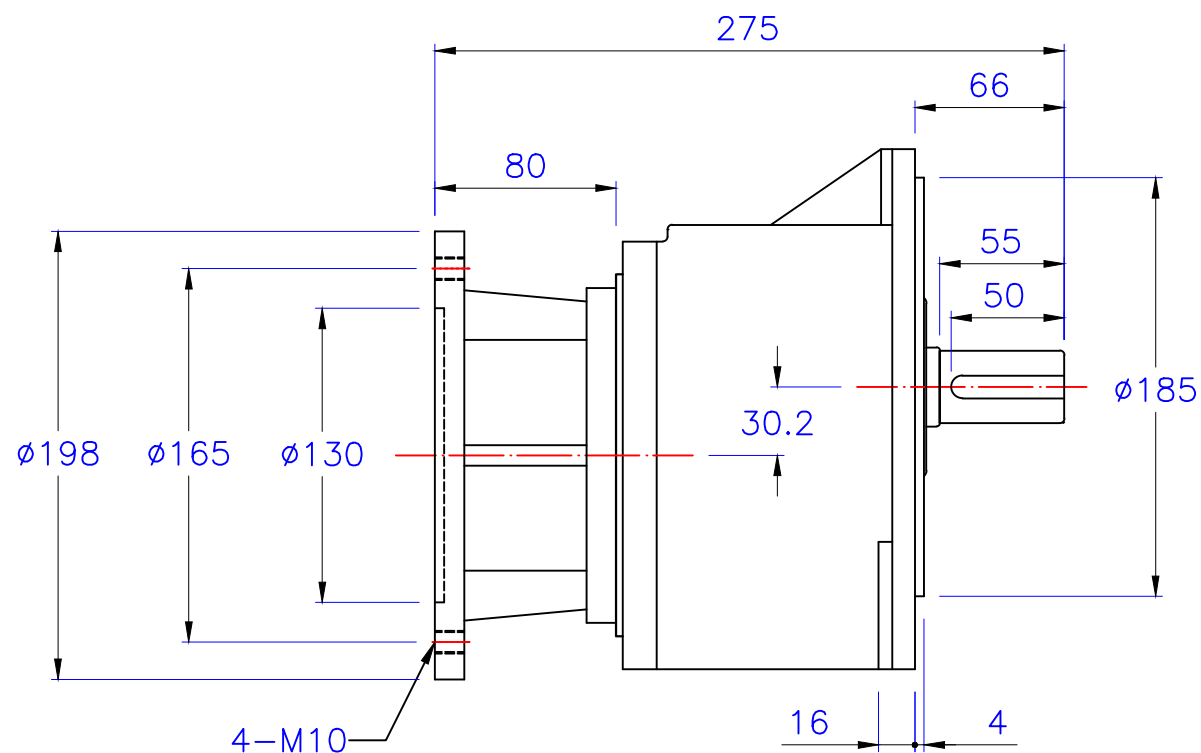

版權
所有

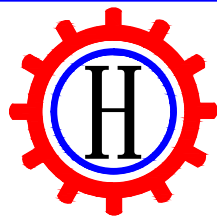

東莞豪鑫機電有限公司
DONG GUAN HOU SIN CO., LTD.
Tel: 86-769-81568855
Fax: 86-769-81568858
Http://www.housinmotor.com

2HP 立式直結型齒輪減速機

圖號	GVM32-1500-3~25	繪圖	肖飞平
版本	第三版	審核	
修訂日期	2015-5-11	比例	1:1