

入力轴
Input shaft

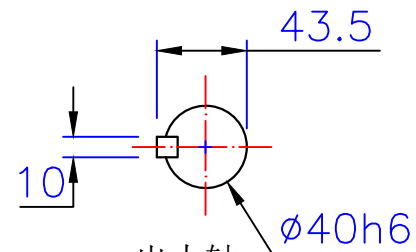

出力轴
Output shaft

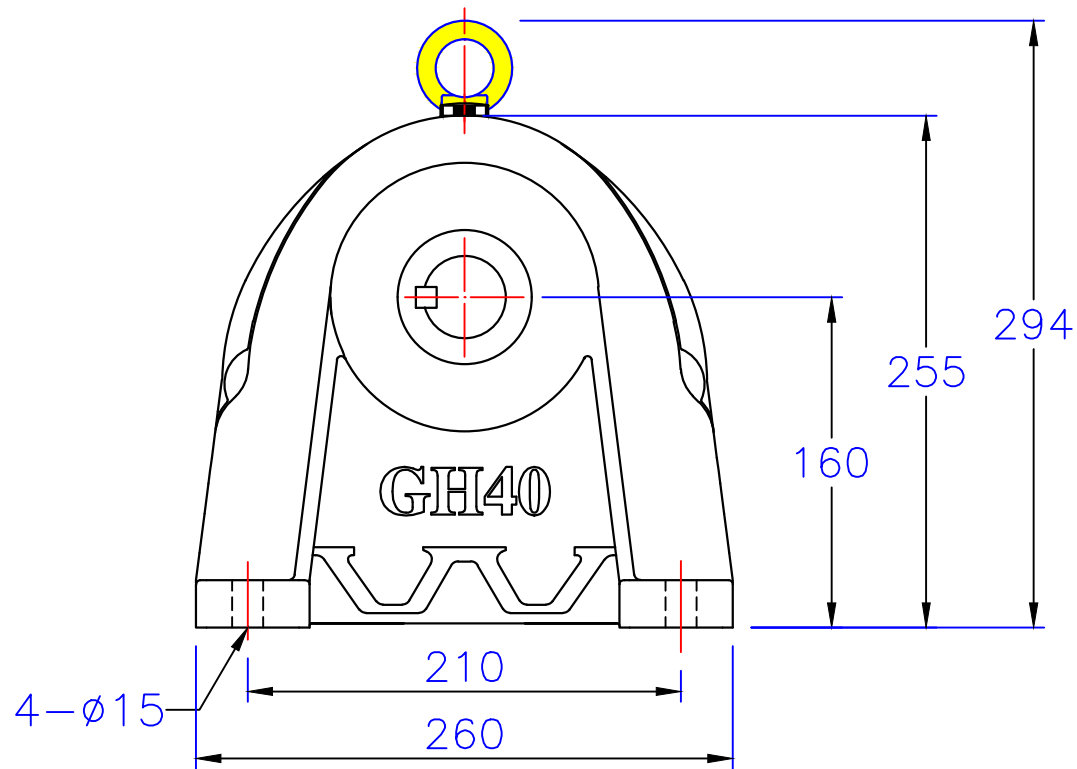
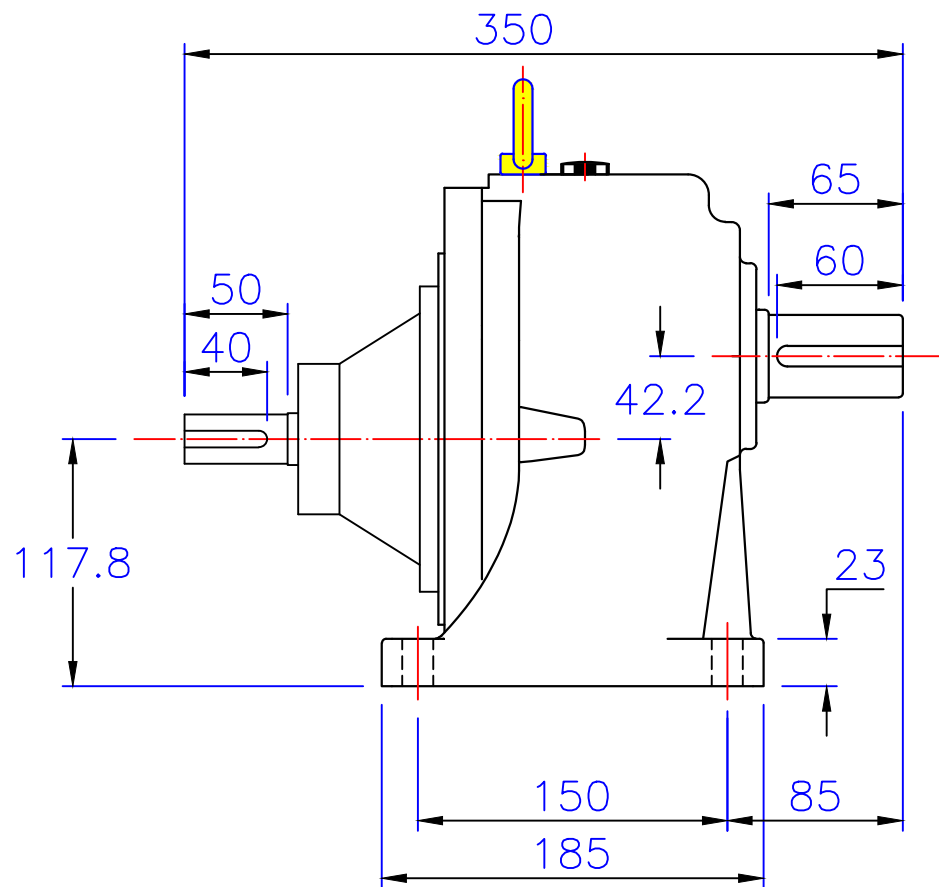

版权
所有

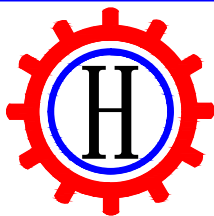

東莞豪鑫機電有限公司
DONG GUAN HOU SIN CO.,LTD.
Tel:86-769-81568855
Fax:86-769-81568858
Http://www.housinmotor.com

2HP臥式雙軸型齒輪減速機

圖號	GHD40-1500-30~120	繪圖	肖飞平
版本	第二版	審核	
修訂日期	2014-7-17	比例	1:1