

入力轴
Input shaft

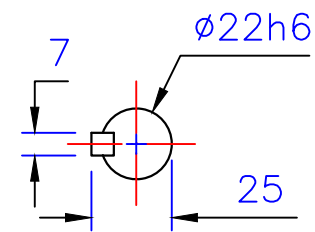

出力轴
Output shaft

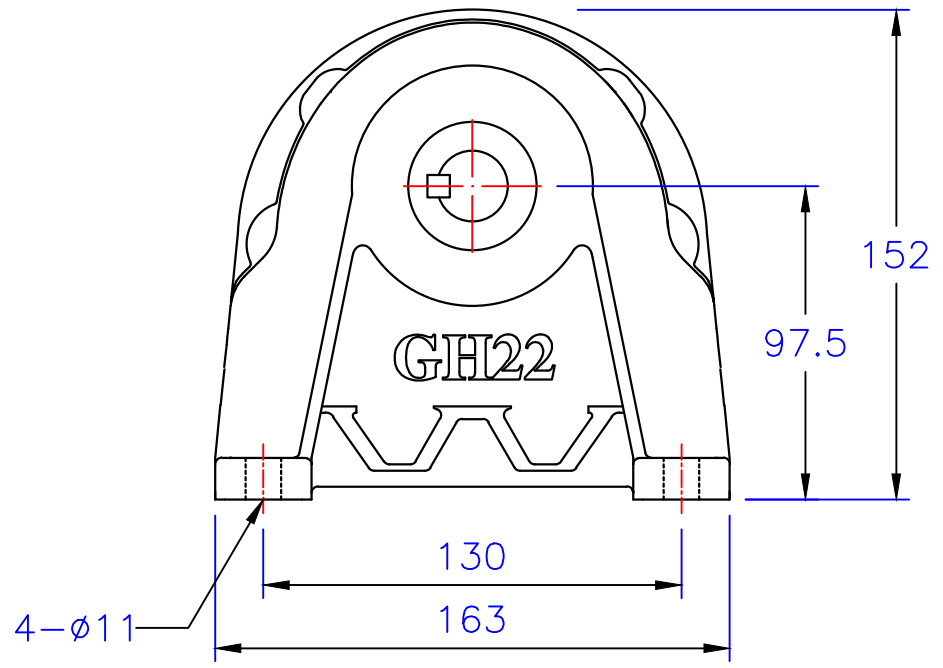
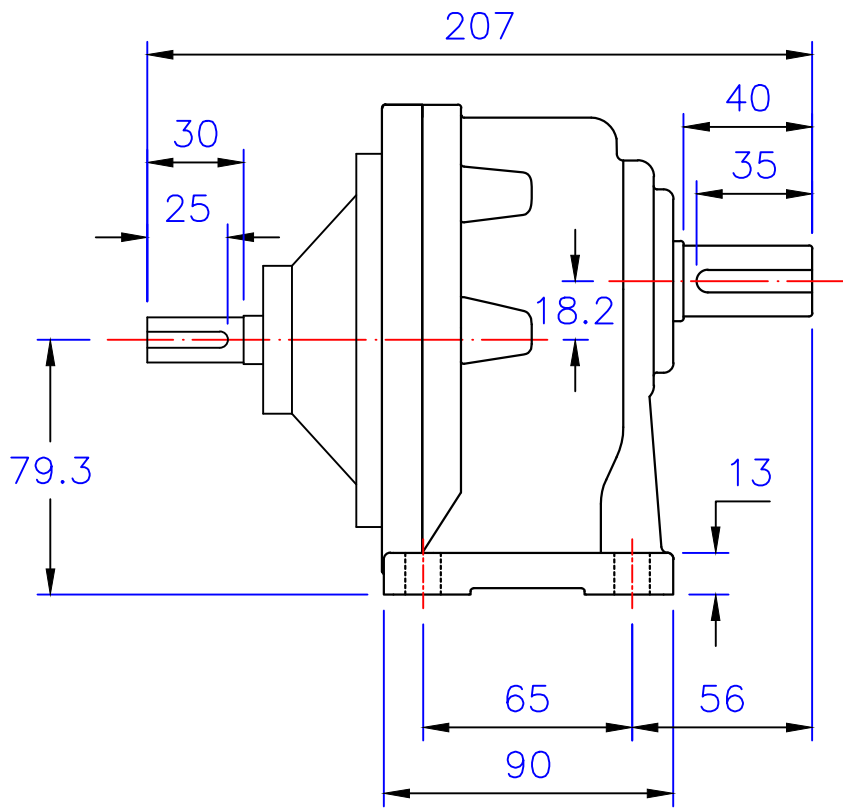

版权所有

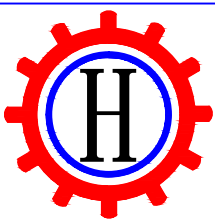

東莞豪鑫機電有限公司
DONG GUAN HOU SIN CO.,LTD.
Tel:86-769-81568855
Fax:86-769-81568858
Http://www.housinmotor.com

1/2HP臥式雙軸型齒輪減速機

圖號	GHD22-400-3~10	繪圖	肖飛平
版本	第二版	審核	
修訂日期	2014-7-17	比例	1:1